



Model: **16-306L** Item #: _____ Date: _____

Project: _____ Qty: _____ Approved By: _____

Single Hole Deck Mount Pantry Faucet with 6" Swing Spout

Royal Series



DESCRIPTION

- Single Hole Deck Mount Pantry Faucet with 6" Swing Spout, Polish Chrome Finish, 1.8 GPM Aerator Installed

STANDARD FEATURES

- 1/4 Turn high performance ceramic cartridge valve with integral check
- 1-1/8" OD x 2-1/4" shank
- 20" Water lines with 3/8 compression fittings
- Durable full range swing spout with double o-ring construction
- Lever handles
- Warranty: 3 years

SPECIFICATIONS

Water Inlet	3/8 Compression Fittings
Temp. Range	40°F - 180°F
Pressure	20-120 PSI
Rough In	1-1/4" Hole
Flow Rate	1.8 GPM
Material	Solid Brass
Finish	Polished Chrome
Weight	3 lbs.

PRODUCT COMPLIANCE

- NSF-61 & NSF/ANSI 372
- ASME A112.18.1-2012/CSA B125.1-12 & NSF/ANSI 372
- Massachusetts Approved
- CEC Approved

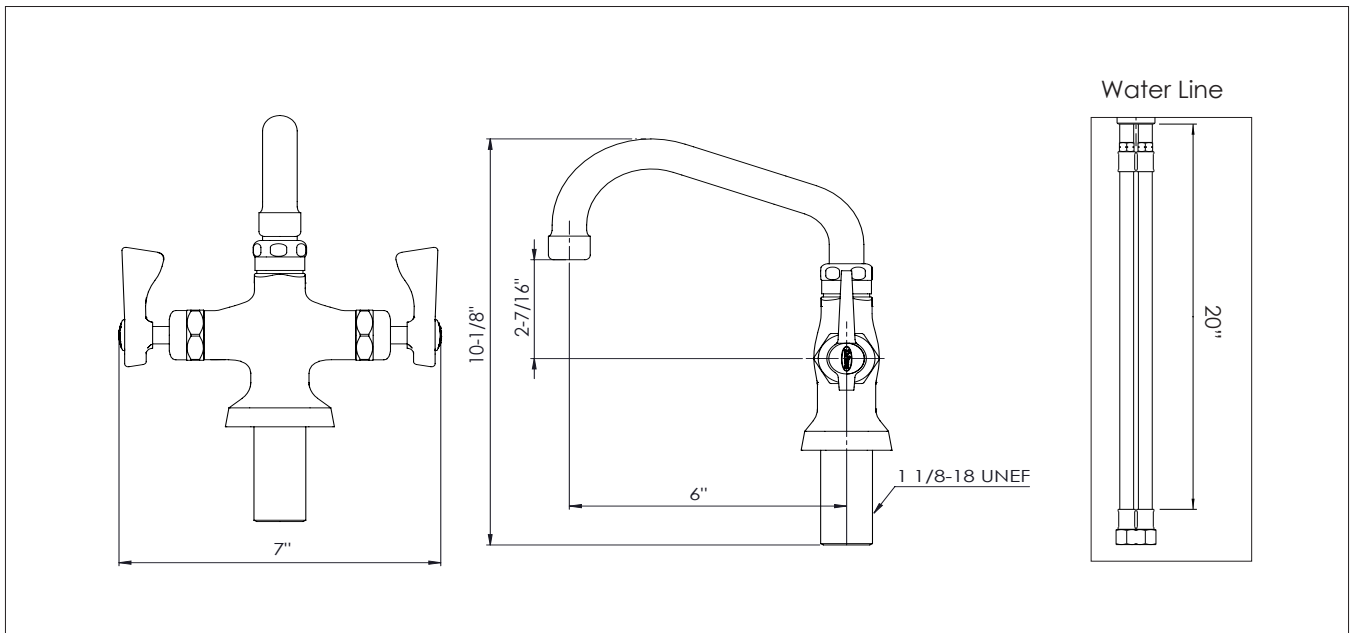

WARNING: Plumbing connections should be made by qualified personnel who will observe all applicable plumbing, sanitary and safety codes. California Proposition 65 Warning