

4" Center Deck Mount Pre-Rinse

ROYAL SERIES



Standard Features

- Pre-assembled to cut installation time
- 1/4 turn ceramic cartridge valves
- 44" stainless steel hose with grip
- Interchangeable with most brands
- Built-in check valves
- Built for high volume
- Full replacement parts available
- Includes wall bracket with screws
- Mounting kit (21-194L): Includes (2) 1/2" NPS x 1-1/2" brass nipples, (2) lock nuts, (2) rosette washers and (2) rubber washers

Specifications

Water Inlet	1/2" NPS Female
Temp. Range	40° - 180°F
Mounting Style	Deck Mount
Rough In	Two 7/8" Round Holes
Spray Head Flow Rate	1.2 GPM @ 60 PSI
Material	Solid Brass
Finish	Polished Chrome
Weight	15 lbs.

Model	Description
17-204WL	4" Center Deck Mount Pre-Rinse

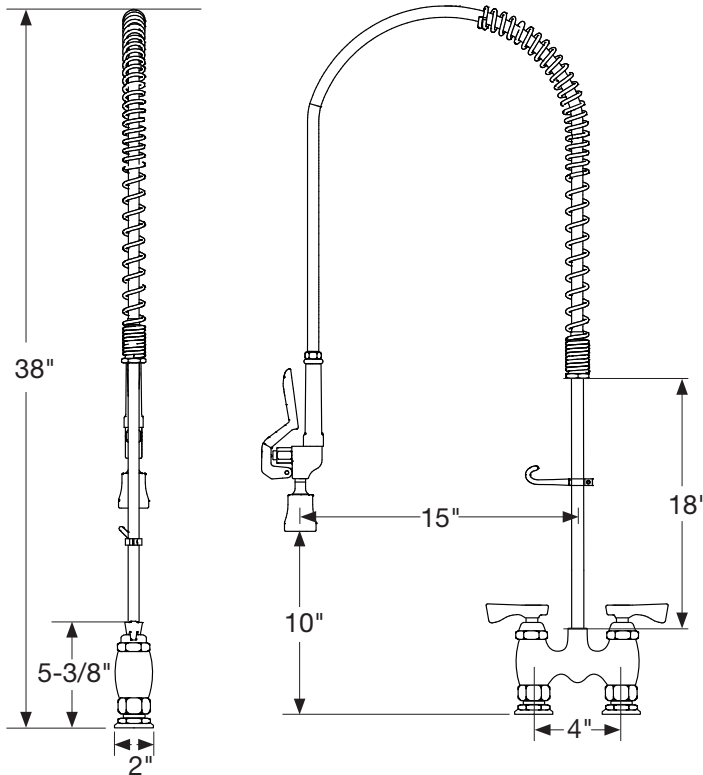

Product Compliance

- NSF-61 & NSF/ANSI 372
- NSF/ANSI/CAN 61: Q < 1
- ASME A112.18.1-2012/CSA B125.1-12
- CEC Listed
- Massachusetts Listed



Warning:

Plumbing connections should be made by qualified personnel who will observe all applicable plumbing, sanitary and safety codes

California Prop 65 Warning:

This product can expose you to chemicals including lead and lead compounds, which are known to the State of California to cause cancer and birth defects or other reproductive harm. For more information go to www.P65Warnings.ca.gov.

4" Center Deck Mount Pre-Rinse

ROYAL SERIES

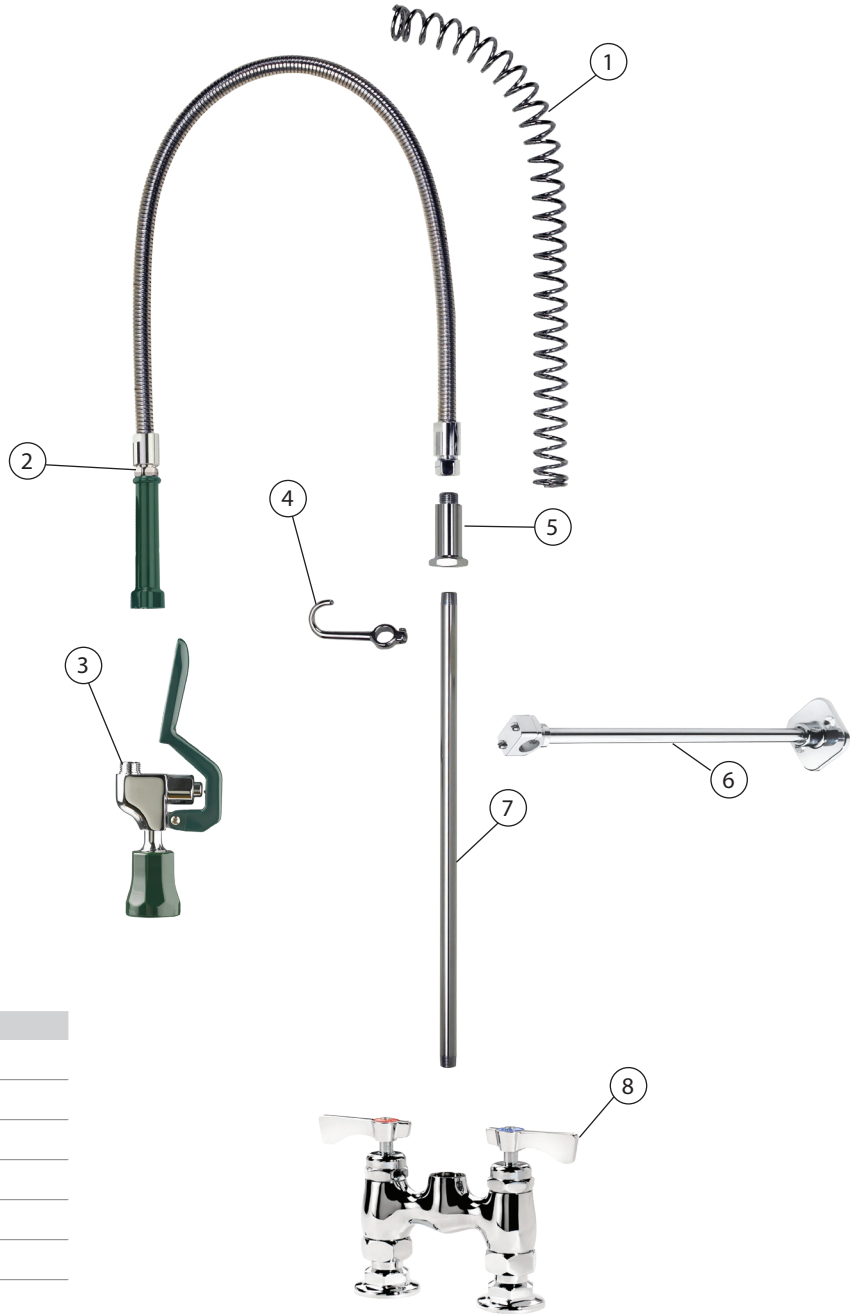

Replacement Parts

No.	Model	Description
1	21-162	24" Spring
2	21-133L	44" Hose with Grip
3	21-129L	1.15 GPM Spray Head
4	21-165	Hook Assembly
5	21-161L	Spring Retainer
6	21-137	Wall Bracket
7	21-160L	18" Riser
8	21-204L	4" Center Deck Mount Pre-Rinse Body

Warning:

Plumbing connections should be made by qualified personnel who will observe all applicable plumbing, sanitary and safety codes

California Prop 65 Warning:

This product can expose you to chemicals including lead and lead compounds, which are known to the State of California to cause cancer and birth defects or other reproductive harm. For more information go to www.P65Warnings.ca.gov.